

4 WATCH A RECORDED PROGRAM

* You can use the available buttons on the remote control or on the VCR.

- 1 Load a cassette with the label facing out and the window facing up.
- 2 Press **REW** or **FF** to find program start point.
- 3 Press **PLAY** to start playback.
- 4 Press **STOP** (remote) or **STOP/EJECT** (VCR), then press **STOP/EJECT** to remove the cassette.

5 RECORD A PROGRAM

a-BASIC RECORDING

* You can use the available buttons on the remote control or on the VCR.

- 1 Load a cassette as above.
- 2 Press **CH**, or press the appropriate **NUMBER** keys (remote) and press **ENTER** (remote), to select the recording channel.
- 3 Press **SP/EP** (remote) to set the recording speed.
- 4 Press **REC** and **PLAY** together (remote) or **REC** (VCR) to start recording.
- 5 Press **PAUSE** to stop recording temporarily, and press **PLAY** to resume.
- 6 Press **STOP** or **STOP/EJECT**, then press **STOP/EJECT** to remove the cassette.

b-INSTANT TIMER RECORDING

* You cannot perform ITR using the remote control.

- 1 Press **REC** to start recording.
- 2 Press **REC** to engage ITR. "0:30" appears in the VCR display.
- 3 To extend duration in increments of 30 minutes, press **REC** as many times as necessary.

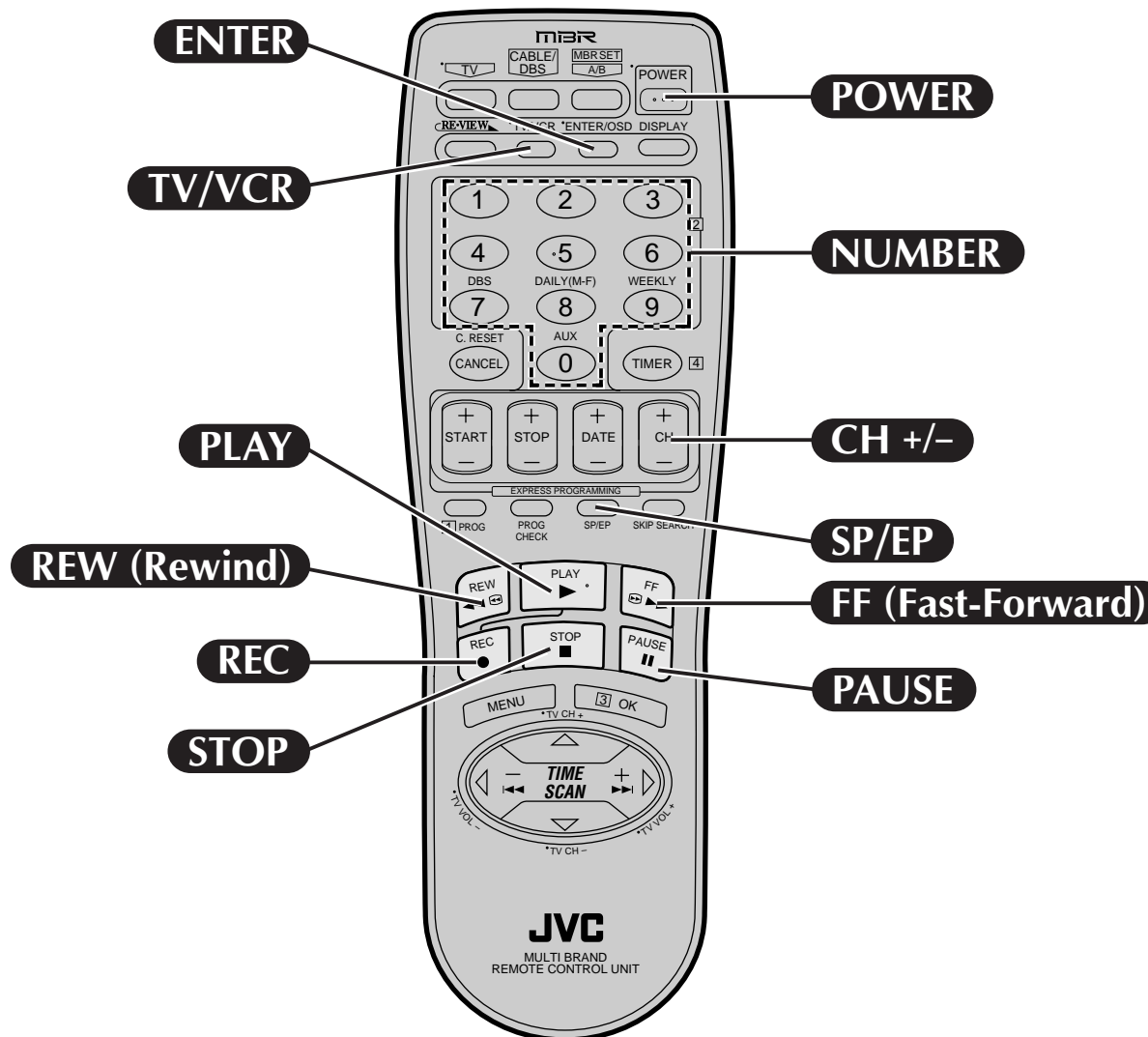
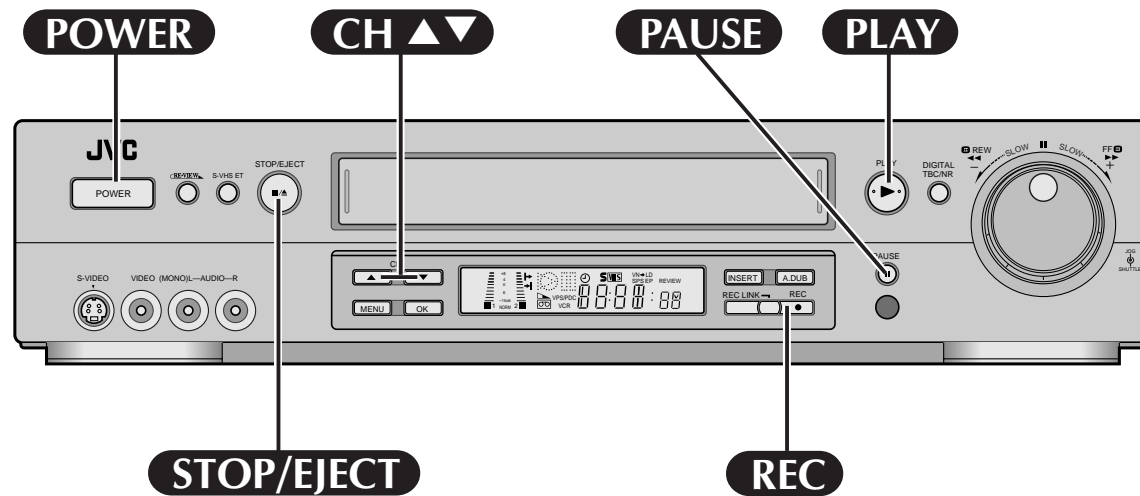
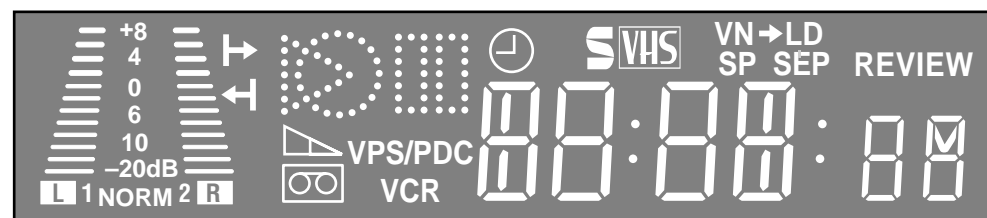

Dear Customer,
Thank you for purchasing
this JVC Video Cassette
Recorder.

QUICK START*

A GUIDE TO EASY SET UP AND USE

JVC

MONO/Hi-Fi/SUPER VHS
VIDEO CASSETTE RECORDERS

* Please refer to the HR-S7600U's instruction manual for more detailed information.

The Path To Enjoyment
Starts Here . . .

- 1 CHECK PACKAGE CONTENTS
- 2 SITUATE AND CONNECT VCR
- 3 SET CLOCK AND TUNER
- 4 PLAY BACK A TAPE
- 5 RECORD A PROGRAM

1 MAKE SURE THAT YOUR PACKAGE CONTAINS:

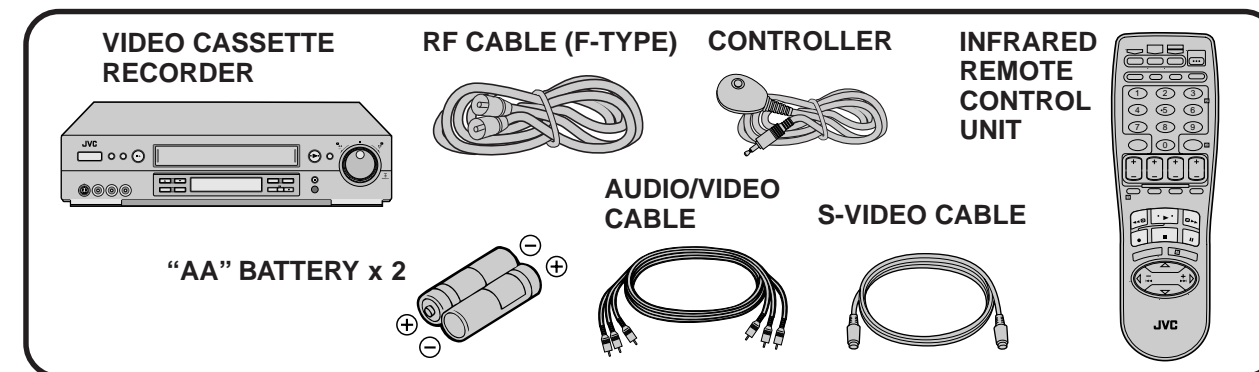

Printed in Malaysia
0599 IYV*MM*PJ

COPYRIGHT © 1999 VICTOR COMPANY OF JAPAN, LTD.

LPT0240-002A

2 SITUATE AND CONNECT YOUR NEW VCR

a-BASIC ANTENNA/CABLE CONNECTION

- ① Place the VCR on a stable, horizontal surface.
- ② Disconnect your antenna or cable line from your TV.
- ③ Connect your antenna to your VCR.
- ④ Connect your VCR to your TV.
- ⑤ After completing the basic connections:
 - If you're using a Cable Box, . . . go to **2b** (CATV CONVERTER CONNECTION).
 - If you're using an AV connection, . . . go to **2c** (AUDIO/VIDEO CONNECTIONS).
 - If you're using an RF connection, . . . go directly to **3** (PLUG & PLAY).

RF CONNECTION

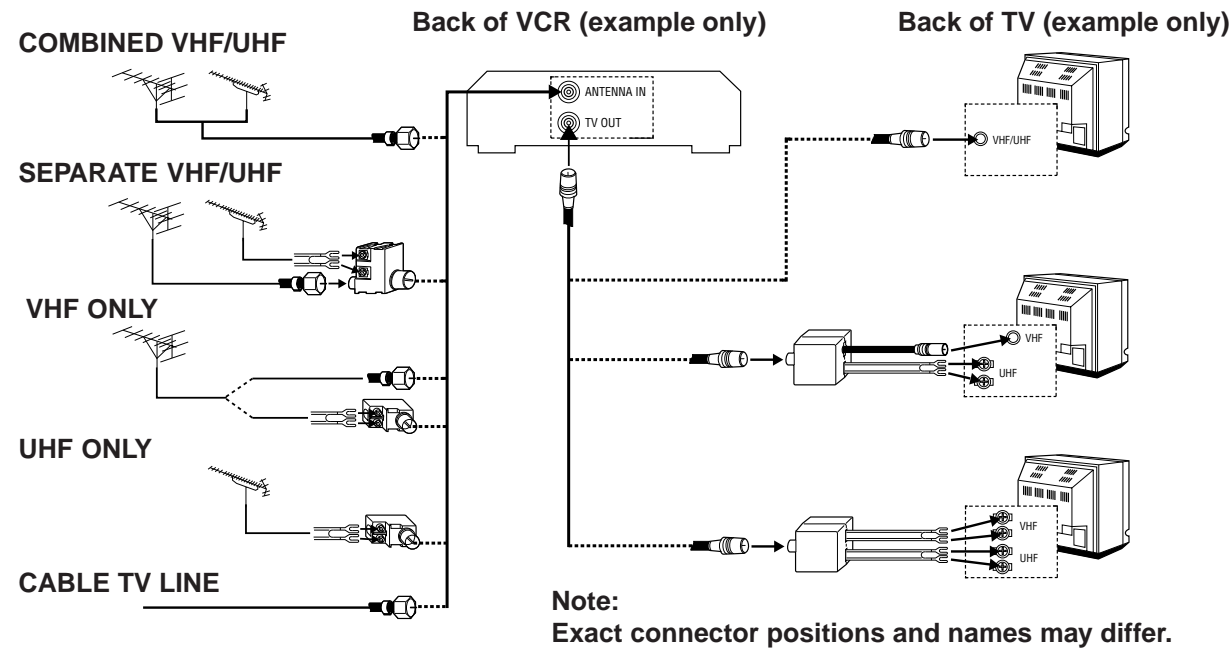

CONNECTORS WHICH ARE OR MAY BE REQUIRED:

<p>■ RF Cable</p>	<p>■ 300-75 ohm Matching Transformer</p>	<p>■ VHF/UHF Antenna Mixer</p>
<p>■ Antenna Splitter</p>	<p>■ Antenna Splitter</p>	

b-CATV CONVERTER CONNECTION

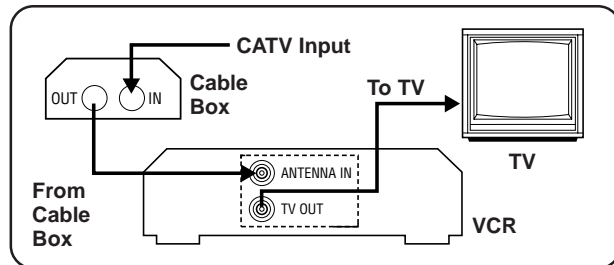

With this connection you can view/record any cable channel including scrambled channels to which you have subscribed.

To watch TV with this type of connection

- ① Press **TV/VCR** on remote to engage VIDEO mode.
- ② Tune TV to VCR output channel (3, 4 or AV mode).
- ③ Tune VCR to Cable Box output channel.
- ④ Select desired channel on Cable Box.
 - You can only view the channel you're recording.
 - You cannot change channels with the VCR remote control.

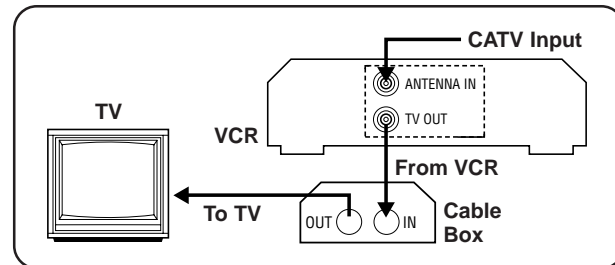

With this connection, you can view one scrambled cable channel while recording another unscrambled channel.

To watch TV with this type of connection

- ① Press **CH** or **NUMBER** keys to select desired channel for recording.
- ② Press **TV/VCR** to engage TV mode.
- ③ Tune TV to Cable Box output channel.
- ④ Select desired channel on Cable Box.
 - You cannot record scrambled channels.
 - To play back a tape, you must tune the Cable Box to the VCR output channel.

c-AUDIO/VIDEO CONNECTIONS

AV connection methods differ from one type of VCR to another. First, for any TV and VCR type, connect your VCR to your TV using RF connection. Then make AV connections following one of the methods pictured to the right. After making the connections, go to **3** (PLUG & PLAY).

Hi-Fi VHS VCR → AV STEREO TV

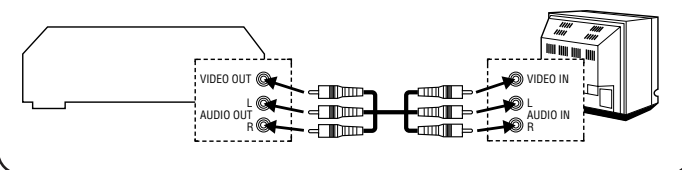

MONAURAL VHS VCR → AV TV

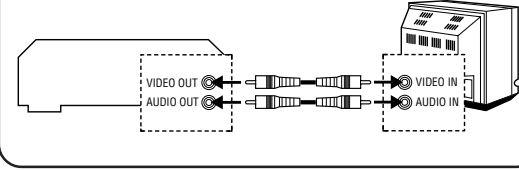

SUPER VHS VCR → AV STEREO TV WITH S-VIDEO INPUT TERMINALS

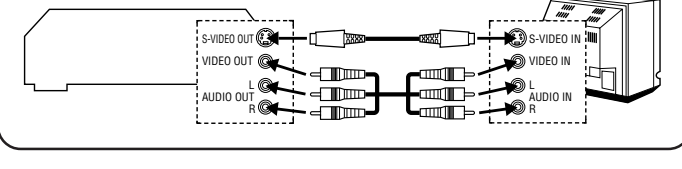

To Listen To VCR Sound Through A Component Stereo Audio System, Connect As Shown

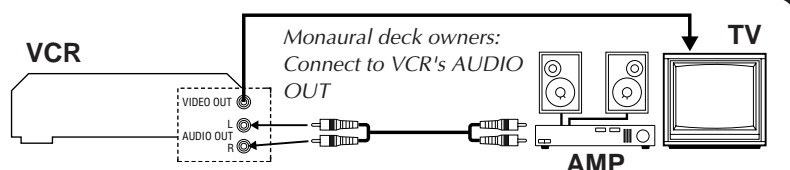

3 SET YOUR VCR'S CLOCK AND TUNER

PLUG & PLAY

The VCR's clock and tuner channels are set automatically when the VCR is plugged into the AC outlet. If you use a cable box, Plug & Play will not function; set the clock and tuner channels manually. (pg.11 - 15 of the HR-S7600U's instruction manual)

- 1 Plug the VCR into the AC outlet.

- 2 Don't press any buttons on the VCR or remote during auto setup.

- 3 "AUTO" blinks while the VCR automatically sets the clock using information provided by the local PBS channel.

NOTES:

- If the time displayed in 5 is incorrect, perform the Semi-Auto or Manual Clock Set procedure (refer to page 12 or 13 of the HR-S7600U's instruction manual). Auto channel set has already taken place, and is not affected.
- There are some PBS channels that do not transmit clock setting data. If your antenna cable is properly connected and "--:--" is displayed, perform the Manual Clock Set procedure (refer to page 13 of the HR-S7600U's instruction manual). Auto channel setting has not yet taken place, so please also perform the "Set Receivable Channels" procedure (refer to page 14 of the HR-S7600U's instruction manual).

- 4

During auto channel setting, the channel numbers are displayed as they are scanned and set. Receivable channels are automatically assigned to CH buttons, and non-receivable channels are skipped.

- 5

When setting is complete, the VCR displays the current time. You can now use your VCR.